

Picnic Table



Complete 3D CAD prints, materials list and step-by-step instructions to build this traditional picnic table.

What you will need

For this project, you will need:

CCA Treated Pine

(13) 6' x2x6's (Have the lumber yard cut 7, 12' boards in half.)

(2) 8' x2x4's

(62) 3" #8 deck screws (1 Lb box)

(16) 3-1/2" Long, 3/8" Carriage bolts with washers and nuts

Tools:

Circular saw

Drill with 3/8" bit

Tape Measure

Square

Crescent Wrench

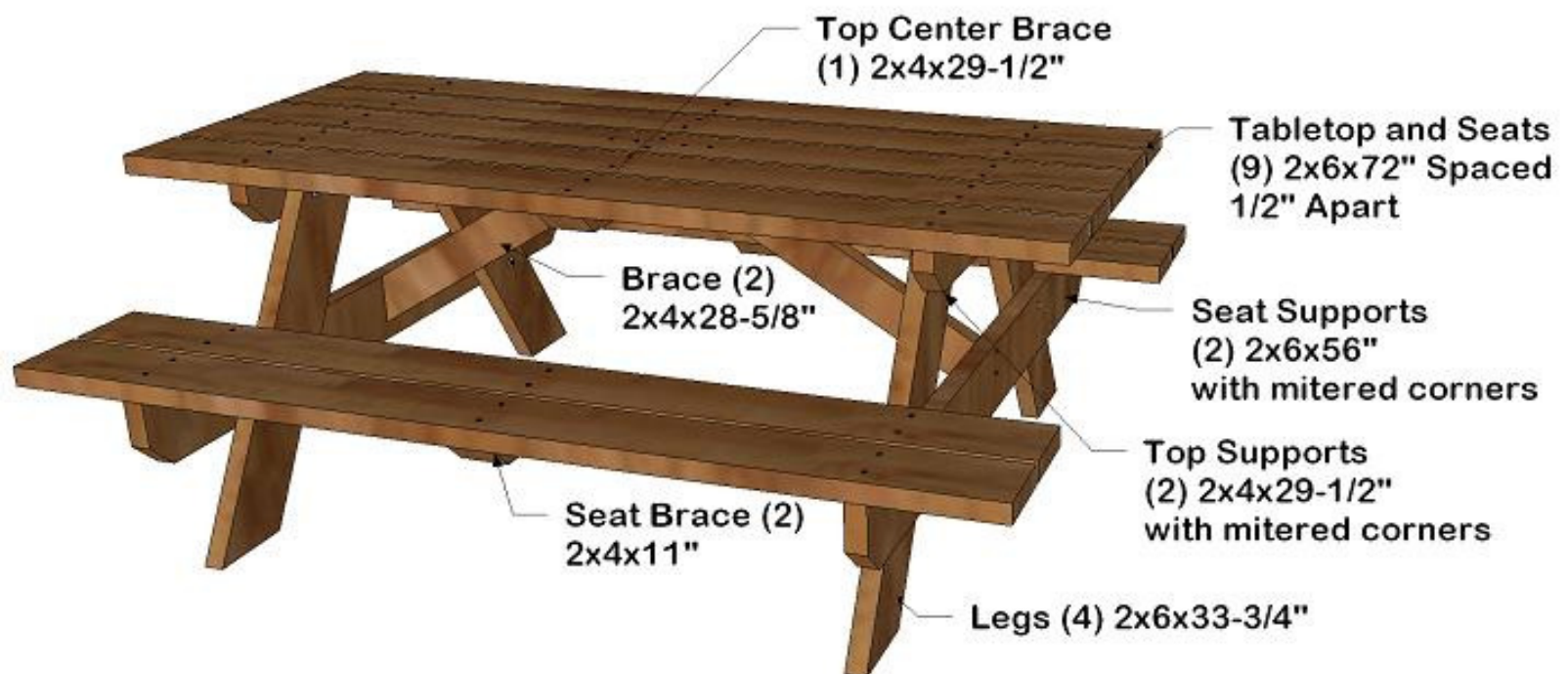

Board Cut Details

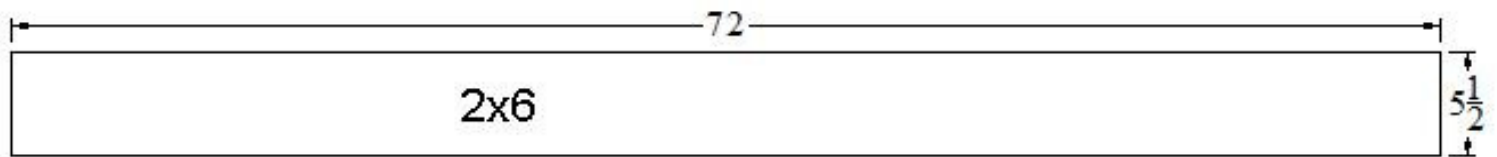
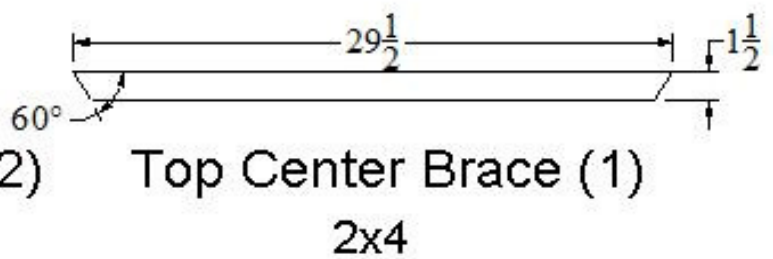
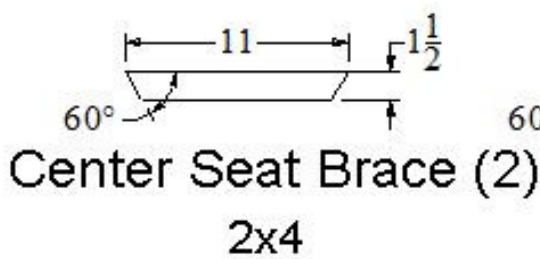
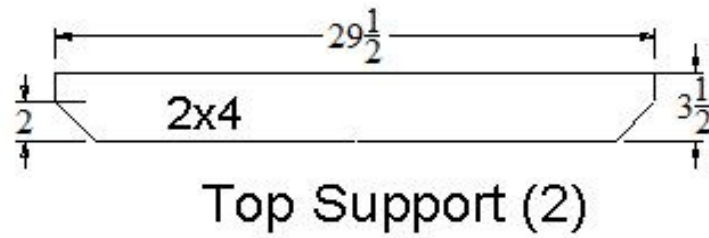
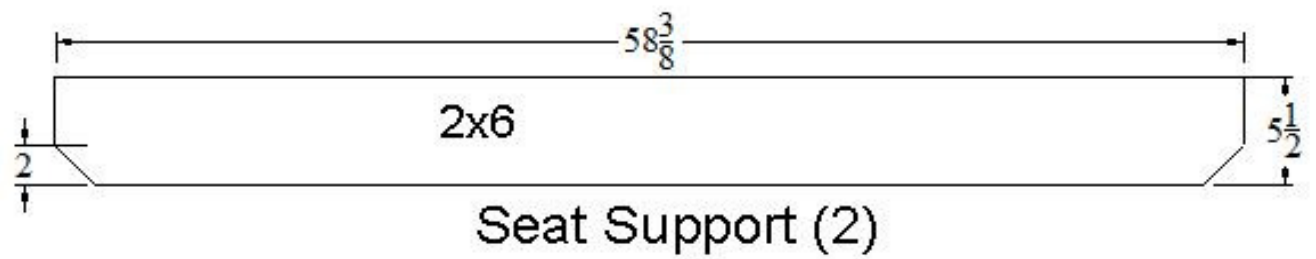
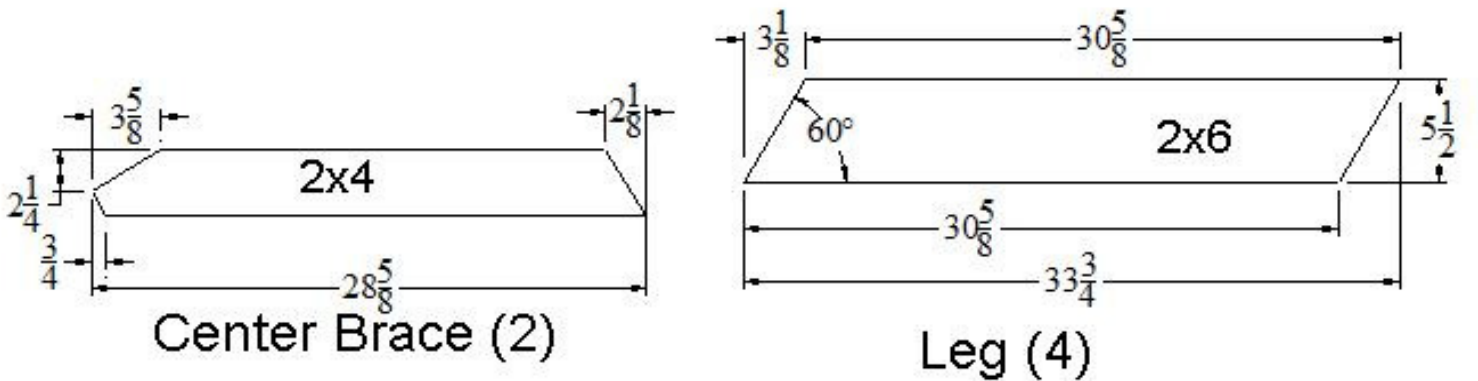

Table Top and Seats (9)

Assembly Dimensions

Start by cutting all the boards and sanding the edges. Lay the legs on a square building surface and fasten the top and seat supports. It's a little tricky but make sure all the dimensions are correct per the drawing below before you bolt the parts together. Then stand them up and fasten the center top board. Make sure it is square and fasten the seat and remainder of the top boards. Finally, while the brats are cooking on the grill, flip the table on it's top and attach the center supports, center top support and braces. Flip it back upright and carefully insert brats in buns. Enjoy!

